

FEDRIS 2 NEW

DC-150

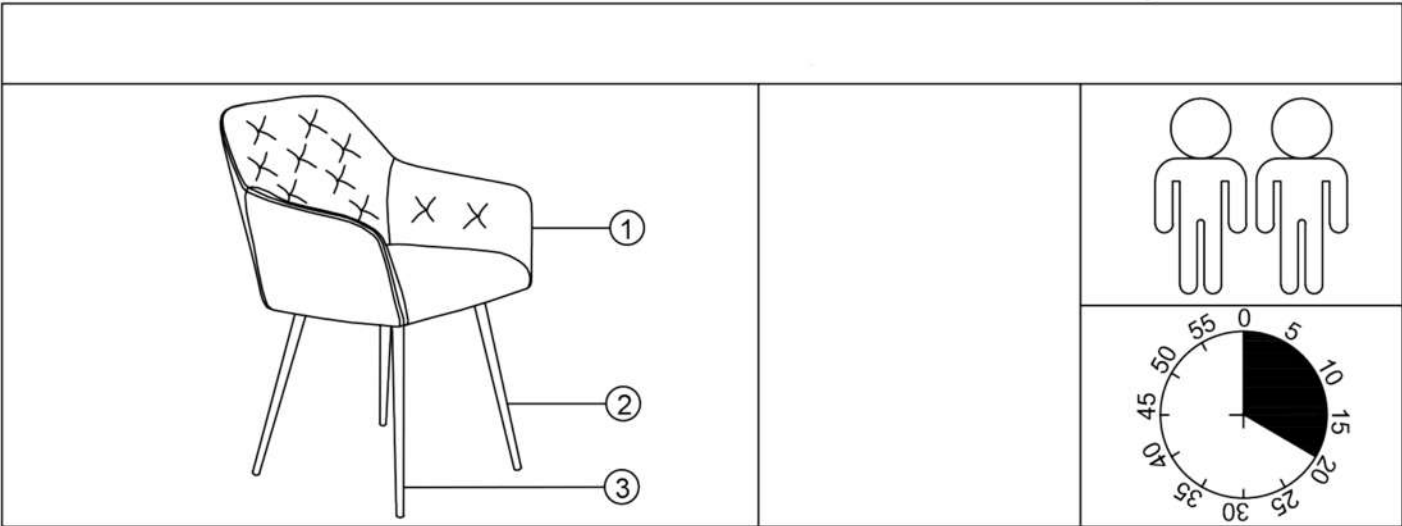

1

2

3

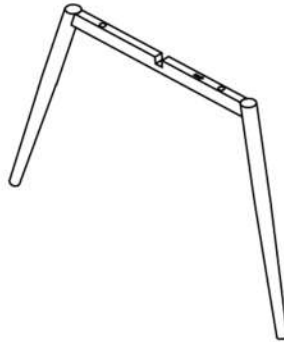
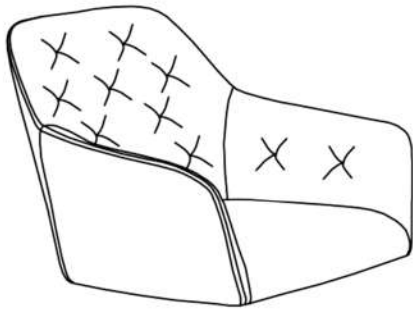

R

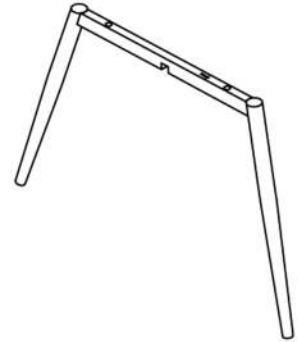

L

1	1 x
2	1 x
3	1 x

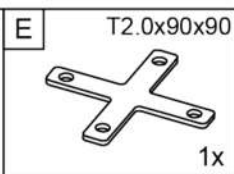
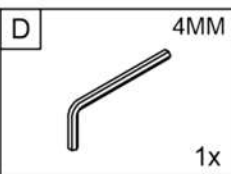
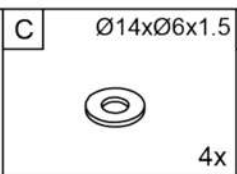
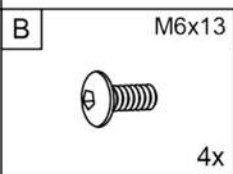
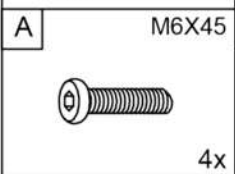
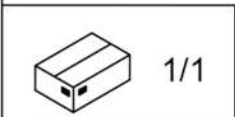

I.

1

3 → L

1 →

D

A

C

A M6x45
2x

C Ø14xØ6x1.5
2x

D 4MM
1x

75%

2

2 → R

D

A

C

A M6x45
2x

C Ø14xØ6x1.5
2x

D 4MM
1x

75%

3

D

B

E

B M6x13
4x

D 4MM
1x

E T2.0x90x90
1x

75%

4

D

4MM

1x

100%

